

# SOLAR MOUNTING SYSTEMS

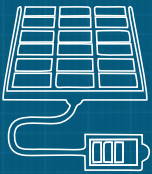

# SOLAR MOUNTING SYSTEMS

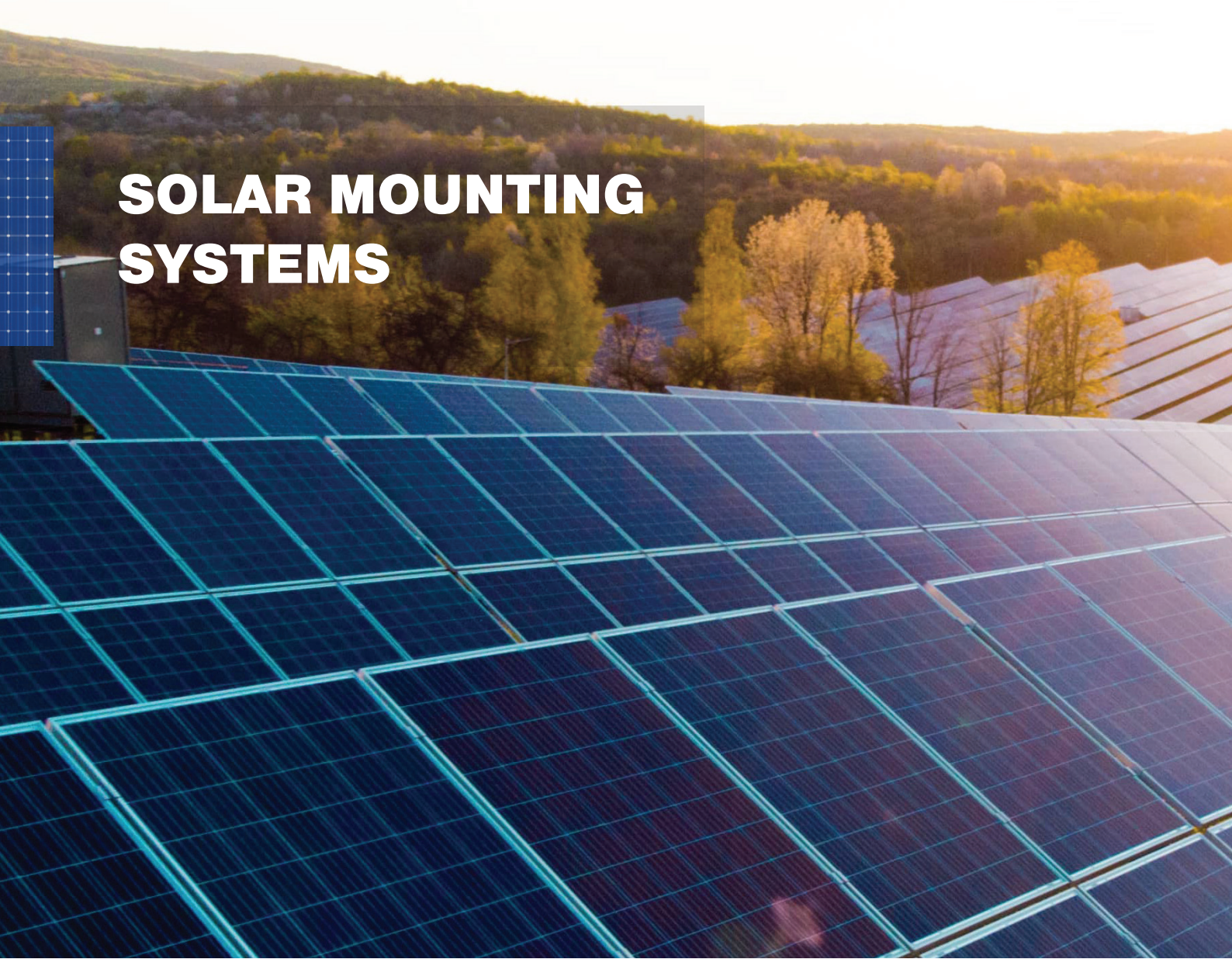

**SPAD**  
CONSULTING ENGINEERS  
*think lateral*



**SGS**

ISO 9001:2015



You can find product sheets, installation instructions and other technical information at [www.umakov.sk](http://www.umakov.sk) in the photovoltaic section



## CONTENT

PITCHED ROOF TILE	6-9
PITCHED ROOF TRAPEZE, CORRUGATED	10-13
PITCHED ROOF STANDING SEAM	14-17
PITCHED ROOF TRAPEZE ADJUSTABLE CONSTRUCTION	18-21
FIXED CONSTRUCTION SOLAR PRO	22-25
FIXED CONSTRUCTION SOLAR ULT	26-27
GROUND SYSTEMS	28-31
CARPORT	32-35
FV PANELS and ACCESSORIES	36-38

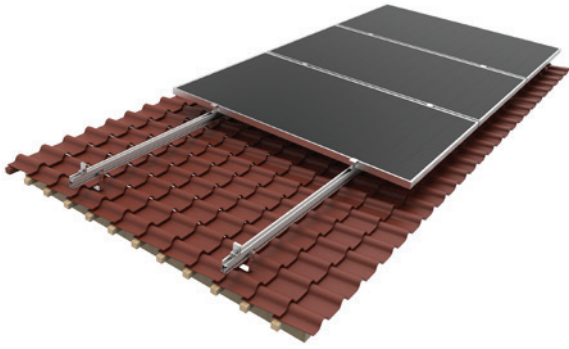

# 1.1

PITCHED ROOF  
TILE

6 - 9

# 1.2

PITCHED ROOF  
STANDING SEAM

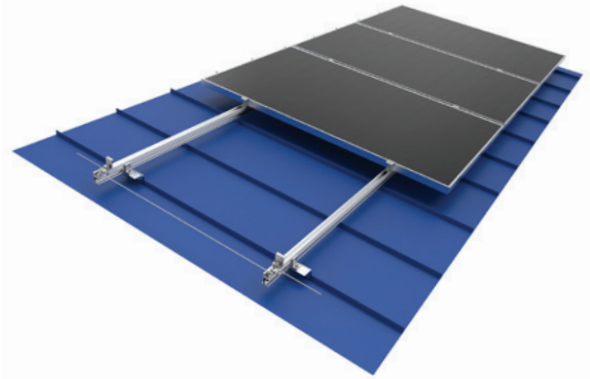

10 - 13

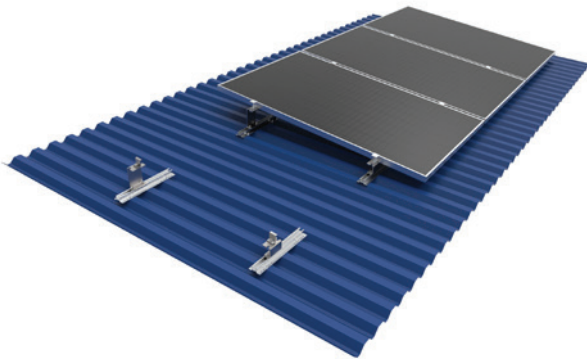

# 1.3

PITCHED ROOF  
TRAPEZE, CORRUGATED

14 - 17

# 1.4

PITCHED ROOF  
TRAPEZE ADJUSTABLE CONSTRUCTION

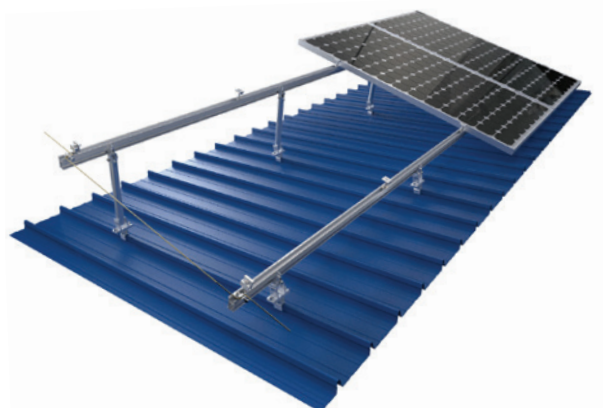

18 - 21

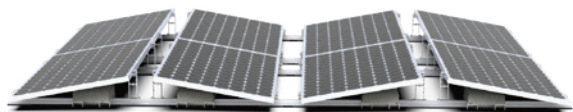
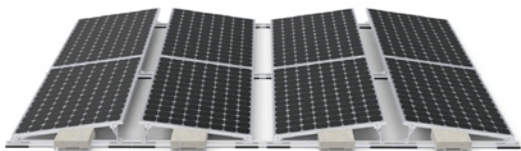

**2**

**2.1**

**FIXED CONSTRUCTION  
SOLAR PRO**

**2.2**

**FIXED CONSTRUCTION  
SOLAR ULT**

**22 - 27**

**3**

**GROUND SYSTEMS**

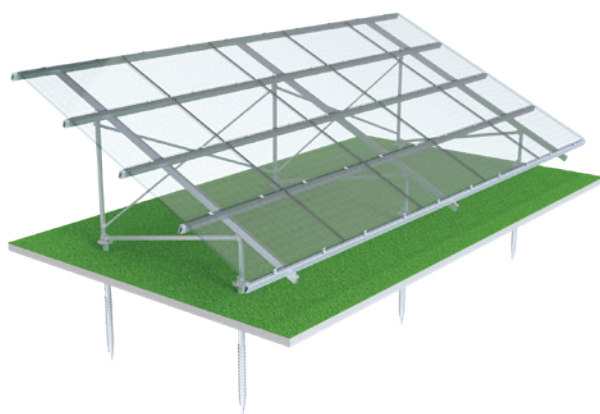

**28 - 31**

**4**

**CARPORT**



**32 - 35**

**5**

**FV PANELS and ACCESSORIES**

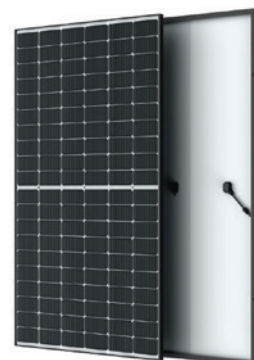

**36 - 38**

# 1.1 PITCHED ROOF

## TILE

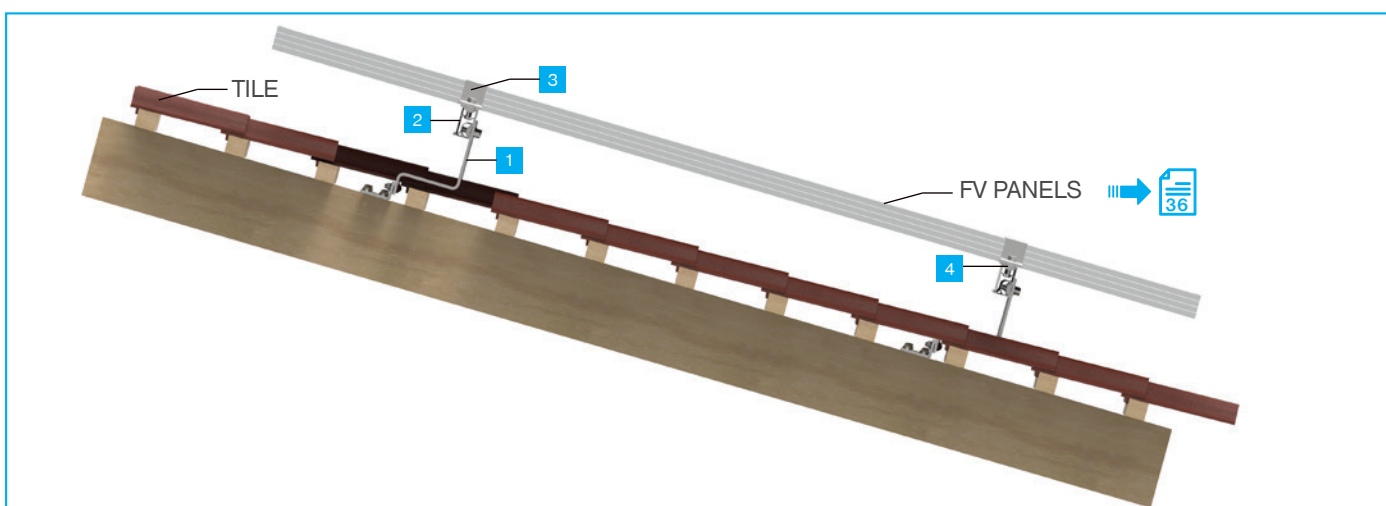
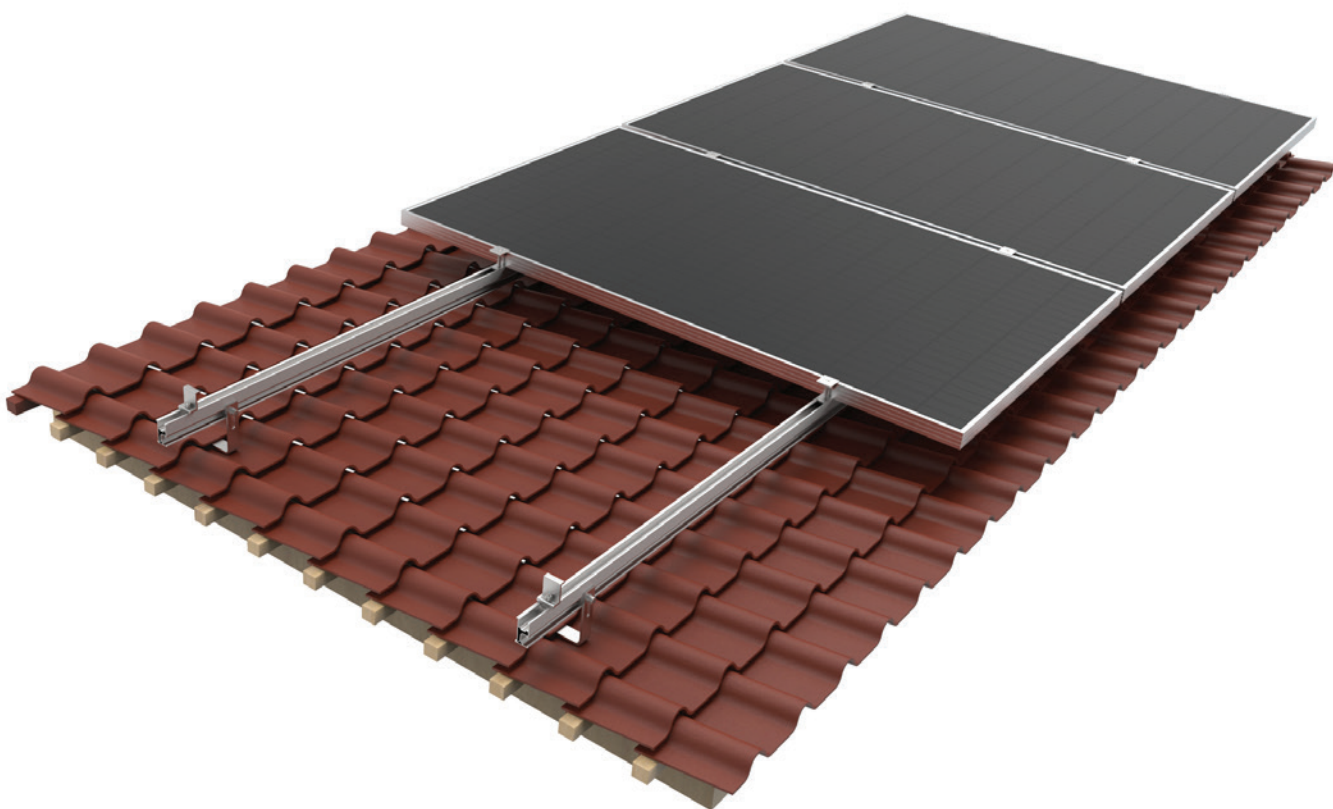

### SPECIFICATION

Application	Tile roof
Slope	Parallel with roof
Material	AL 6005-T5, SUS 304
Finish	AL6005-T5 elox

Orientation	Portrait, Landscape
Warranty	10 years
LOAD	60km/h 1,4kN/m <sup>2</sup>



1

## HOOKS

- SOL-TRH-T01
- SOL-TRH-T06
- SOL-TRH-T07
- SOL-TRH-T08
- SOL-TRH-T14
- SOL-TRH-T18
- SOL-TRH-S01
- SOL-TRH-F06
- SOL-TRH-T19
- SOL-TRH-AL1



1

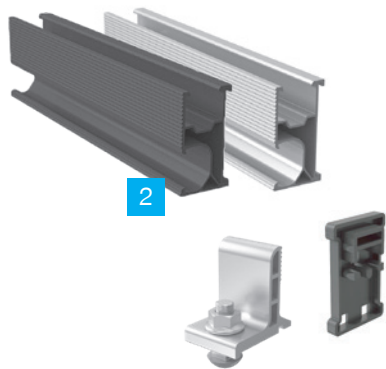

2

## PROFILES

SOL-R52



3

## CLAMPS

- SOL-FEC...
- SOL-AEC
- SOL-EIC



4

## ACCESSORIES



# HOOKS

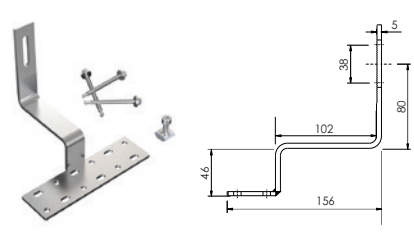

Material	Finish	Effect	art.
AISI304	raw	silver	SOL-TRH-T01

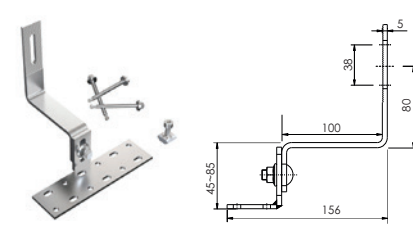

Material	Finish	Effect	art.
AISI304	raw	silver	SOL-TRH-T06

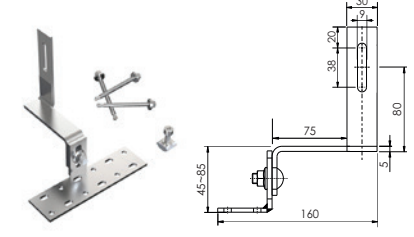

Material	Finish	Effect	art.
AISI304	raw	silver	SOL-TRH-T07

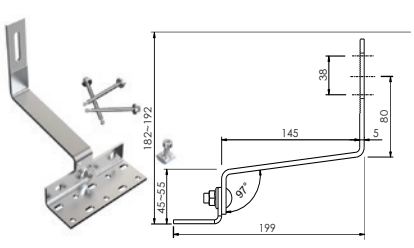

Material	Finish	Effect	art.
AISI304	raw	silver	SOL-TRH-T08

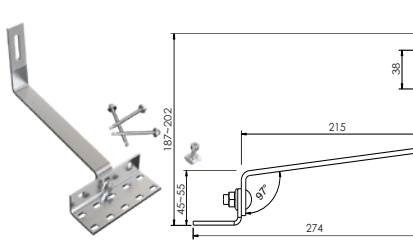

Material	Finish	Effect	art.
AISI304	raw	silver	SOL-TRH-T18

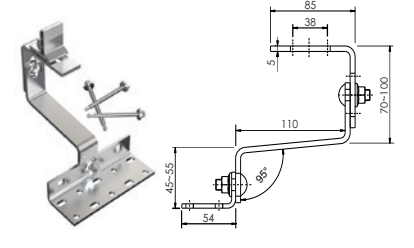

Material	Finish	Effect	art.
AISI304	raw	silver	SOL-TRH-T14

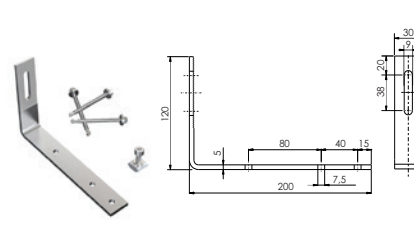

Material	Finish	Effect	art.
AISI304	raw	silver	SOL-TRH-S01

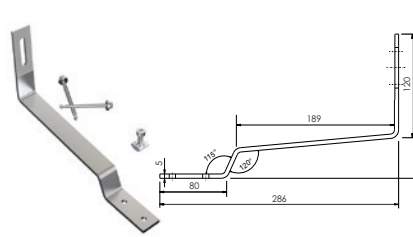

Material	Finish	Effect	art.
AISI304	raw	silver	SOL-TRH-F01



Material	Finish	Effect	art.
AISI304	raw	silver	SOL-TRH-T19

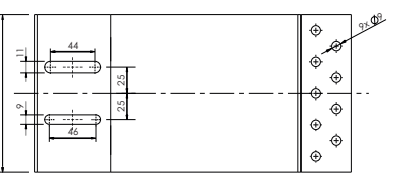
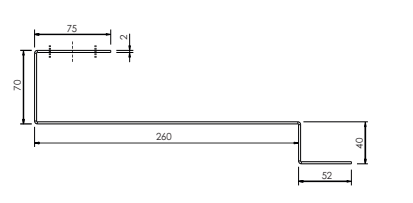

Material	Finish	Effect	art.
ANODIZED ALUMINIUM	natural	silver	SOL-TRH-T29



# PROFILES

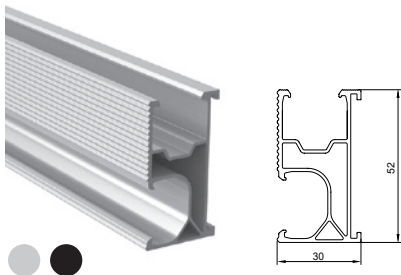

Material	Finish	Effect	art.	L
ANODIZED ALUMINIUM	natural	silver	SOL-R52-2200	2200
		black	SOL-R52-3000	3000
		black	SOL-R52-3000-B	3000
		silver	SOL-R52-4700	4700
		black	SOL-R52-4700-B	4700
		silver	SOL-R52-5000	5000
		black	SOL-R52-5000-B	5000



Material	Finish	Effect	art.	L
ANODIZED ALUMINIUM	natural	silver	SOL-SFR-01	150
		black	SOL-SFR-01-B	



Material	Finish	art.
Rubber (EPDM)	black	SOL-REC

# CLAMPS

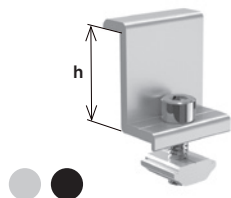

Material	Finish	Effect	art.	h
ANODIZED ALUMINIUM	natural	silver	SOL-FEC-30	30
		black	SOL-FEC-30-B	
		silver	SOL-FEC-35	35
		black	SOL-FEC-35-B	

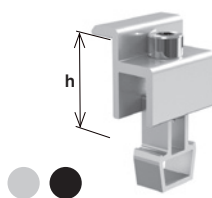

Material	Finish	Effect	art.	h
ANODIZED ALUMINIUM	natural	silver	SOL-AEC	30-35
		black	SOL-AEC-B	

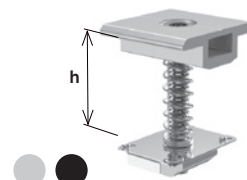

Material	Finish	Effect	art.	h
ANODIZED ALUMINIUM	natural	silver	SOL-EIC	30-40
		black	SOL-EIC-B	

# ACCESSORIES



Material	Finish	Effect	art.
ANODIZED ALUMINIUM	natural	silver	SOL-NBW



Material	Finish	Effect	art.
AISI304	raw	silver	SOL-TBK



Material	Finish	Effect	art.
AISI304	raw	silver	SOL-CCP-04



Material	Finish	Effect	art.
AISI304	raw	silver	SOL-REL-B



Material	Finish	Effect	art.
ANODIZED ALUMINIUM	natural	silver	SOL-ELG-03



Material	Finish	Effect	art.
ANODIZED ALUMINIUM	natural	silver	SOL-ELG-05

# 1.2 PITCHED ROOF

## STANDING SEAM

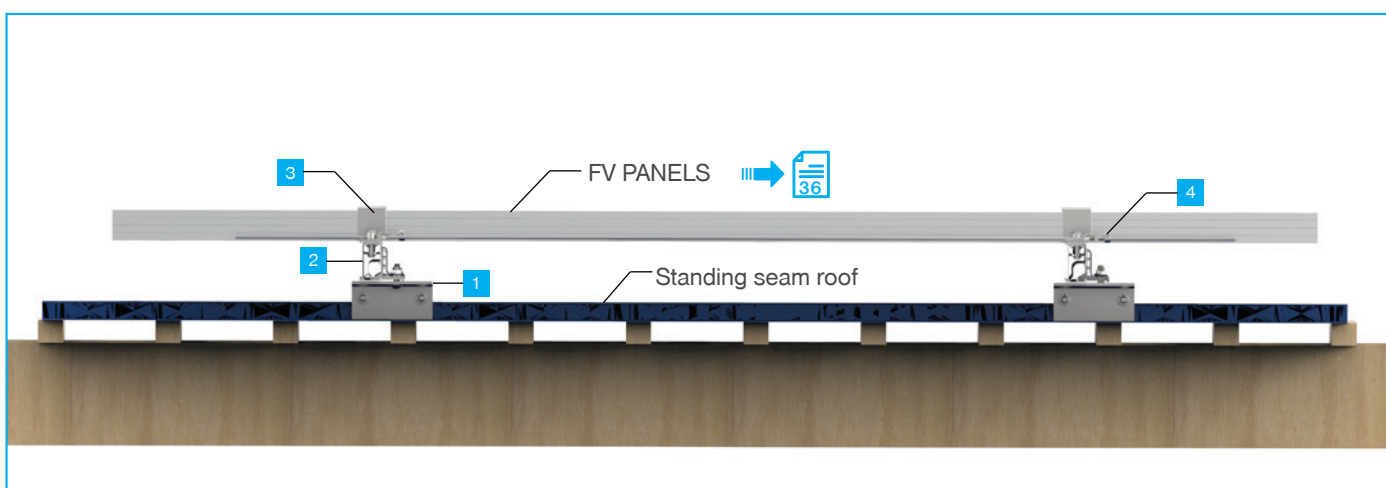
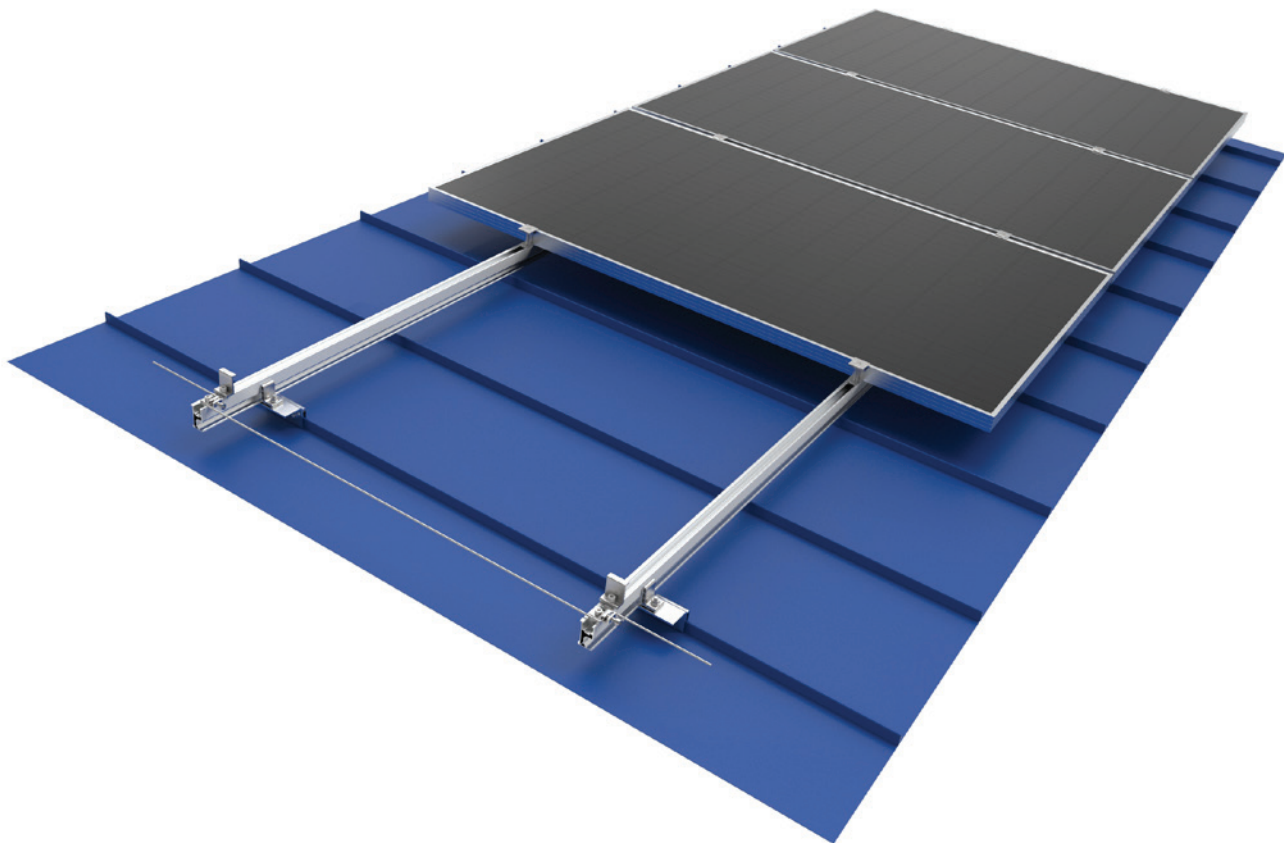

### SPECIFICATION

<b>Application</b>	Standing seam roof
<b>Slope</b>	Parallel with roof
<b>Material</b>	AL 6005-T5, SUS 304, EPDM
<b>Finish</b>	AL6005-T5 elox

<b>Orientation</b>	Portrait, Landscape
<b>Warranty</b>	10 years
<b>LOAD</b>	60km/h 1,4kN/m <sup>2</sup>

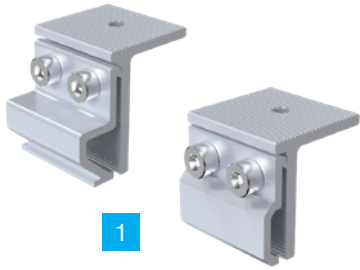

## HOLDERS

SOL-C04  
SOL-C05  
SOL-C10



## PROFILES

SOL-R52-...



## CLAMPS

SOL-FEC...  
SOL-AEC  
SOL-EIC



## ACCESSORIES



# HOLDERS

1.2  
PITCHED ROOF  
STANDING SEAM

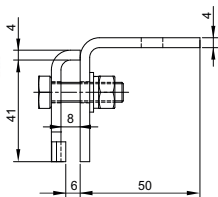

Material	Finish	Effect	art.
AISI304	raw	silver	SOL-TRB-C10

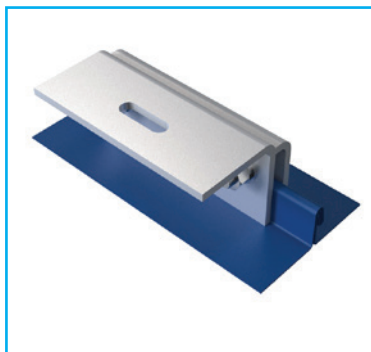

+



Material	Finish	Effect	art.
ANODIZED ALUMINIUM	natural	silver	SOL-RCC

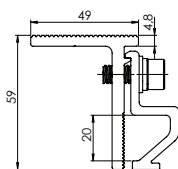
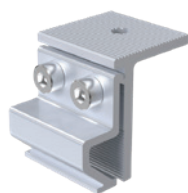

Material	Finish	Effect	art.
ANODIZED ALUMINIUM	natural	silver	SOL-TRB-C04

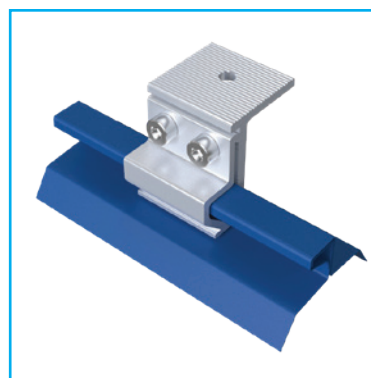

+



Material	Finish	Effect	art.
ANODIZED ALUMINIUM	natural	silver	SOL-RCN

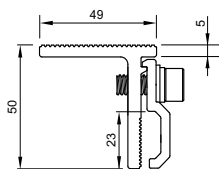

Material	Finish	Effect	art.
ANODIZED ALUMINIUM	natural	silver	SOL-TRB-C05

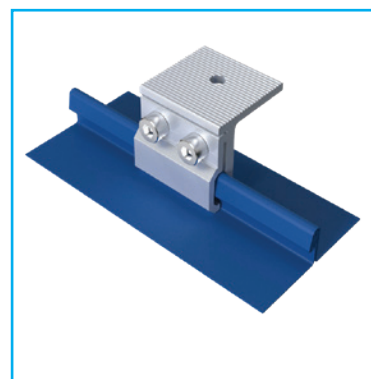

+



Material	Finish	Effect	art.
ANODIZED ALUMINIUM	natural	silver	SOL-RCN

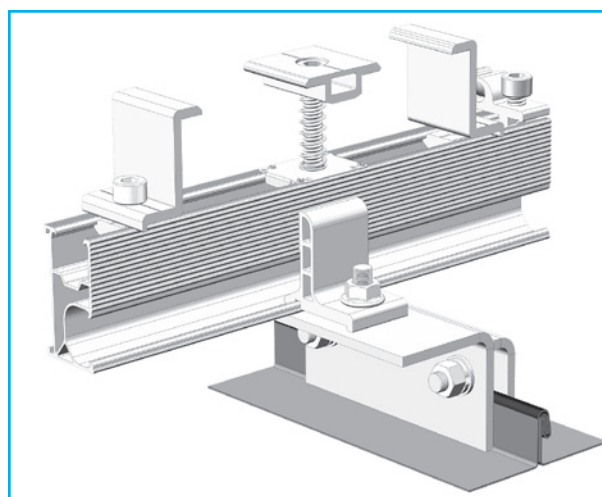

# PROFILES

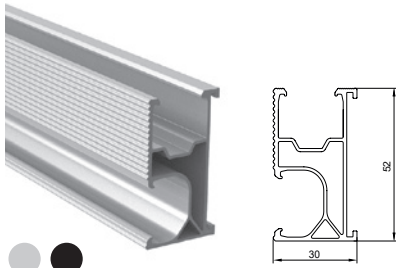

Material	Finish	Effect	art.	L
ANODIZED ALUMINIUM	natural	silver	SOL-R52-2200	2200
		black	SOL-R52-3000	3000
		black	SOL-R52-3000-B	3000
		silver	SOL-R52-4700	4700
		black	SOL-R52-4700-B	4700
		silver	SOL-R52-5000	5000
		black	SOL-R52-5000-B	5000



Material	Finish	Effect	art.	L
ANODIZED ALUMINIUM	natural	silver	SOL-SFR-01	150
		black	SOL-SFR-01-B	



Material	Finish	art.
Rubber (EPDM)	black	SOL-REC

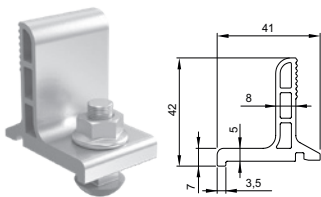

Material	Finish	Effect	art.
ANODIZED ALUMINIUM	natural	silver	SOL-RCC

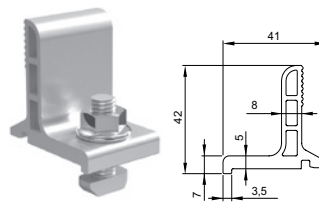

Material	Finish	Effect	art.
ANODIZED ALUMINIUM	natural	silver	SOL-RCB

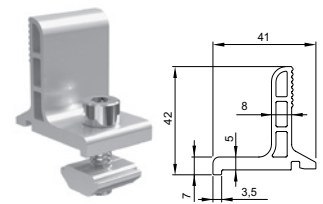

Material	Finish	Effect	art.
ANODIZED ALUMINIUM	natural	silver	SOL-RCN

# CLAMPS

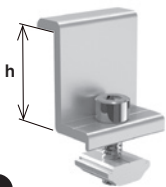

Material	Finish	Effect	art.	h
ANODIZED ALUMINIUM	natural	silver	SOL-FEC-30	30
		black	SOL-FEC-30-B	30
		silver	SOL-FEC-35	35
		black	SOL-FEC-35-B	35

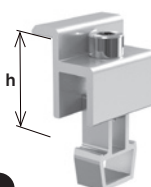

Material	Finish	Effect	art.	h
ANODIZED ALUMINIUM	natural	silver	SOL-AEC	30-35
		black	SOL-AEC-B	30-35

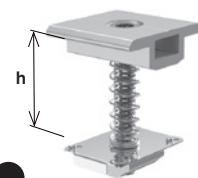

Material	Finish	Effect	art.	h
ANODIZED ALUMINIUM	natural	silver	SOL-EIC	30-40
		black	SOL-EIC-B	30-40

# ACCESSORIES

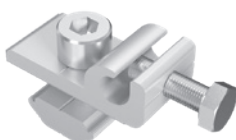

Material	Finish	Effect	art.
ANODIZED ALUMINIUM	natural	silver	SOL-ELG-02



Material	Finish	Effect	art.
ANODIZED ALUMINIUM	natural	silver	SOL-ELG-03



Material	Finish	Effect	art.
ANODIZED ALUMINIUM	natural	silver	SOL-ELG-05

# 1.3 PITCHED ROOF

## TRAPEZE, CORRUGATED

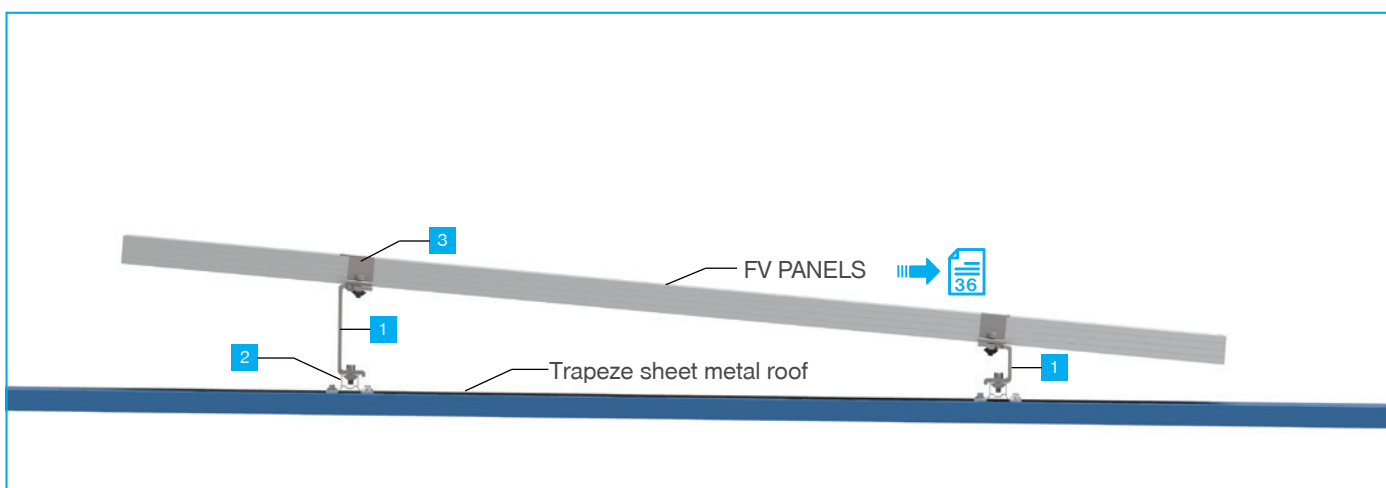
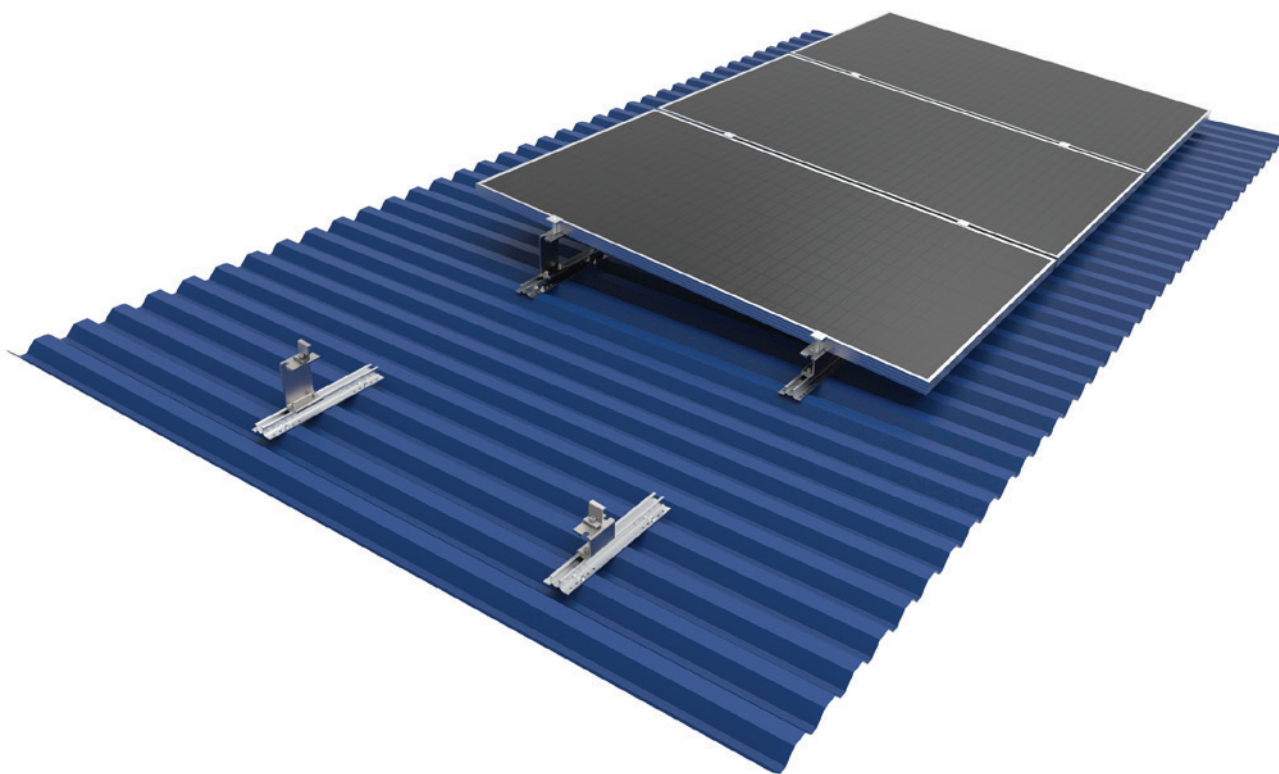

### SPECIFICATION

Application	Sheet metal roof
Slope	5° / 10°
Material	AL 6005-T5, SUS 304, EPDM
Finish	AL6005-T5 elox

Orientation	Portrait, Landscape
Warranty	10 years
LOAD	60km/h 1,4kN/m <sup>2</sup>



## HOLDERS

SOL-TRB-D01  
SOL-TRB-D03  
SOL-TRB-D05  
SOL-TRB-D18  
SOL-TRB-D21  
SOL-TRB-D26...  
SOL-MFS...  
SOL-MRS...

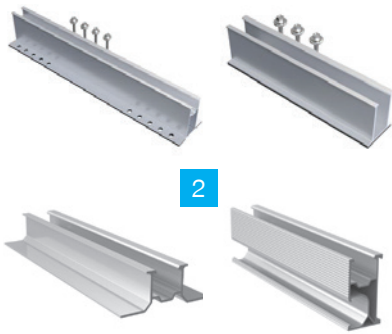

## PROFILES

SOL-TRB-D10  
SOL-TRB-D11  
SOL-TRB-D13  
SOL-TRB-D14  
SOL-R26-...  
SOL-R41-2-...  
SOL-R52-...



## CLAMPS

SOL-FEC...  
SOL-AEC  
SOL-EIC



## ACCESSORIES



# HOLDERS

1.3  
PITCHED ROOF  
CORRUGATED



Material	Finish	Effect	art.
ANODIZED ALUMINIUM	natural	silver	SOL-TRB-D01



Material	Finish	Effect	art.
ANODIZED ALUMINIUM	natural	silver	SOL-TRB-D26-M10x180
			SOL-TRB-D26-M10x200
			SOL-TRB-D26-M10x250
			SOL-TRB-D26-M10x300



Material	Finish	Effect	art.
ANODIZED ALUMINIUM	natural	silver	SOL-TRB-D03



Material	Finish	Effect	art.
ANODIZED ALUMINIUM	natural	silver	SOL-TRB-D05



Material	Finish	Effect	art.
AISI304	raw	silver	SOL-TRB-D21



Material	Finish	Effect	art.
AISI304	raw	silver	SOL-TRB-D18

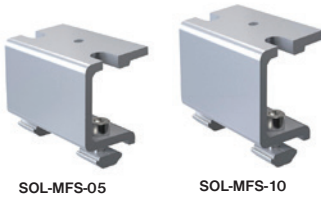

SOL-MFS-05

SOL-MFS-10

Material	Finish	Effect	art.	slope
ANODIZED ALUMINIUM	natural	silver	SOL-MFS-05	5°
			SOL-MFS-10	10°



Material	Finish	Effect	art.	slope
ANODIZED ALUMINIUM	natural	silver	SOL-MRS-05	5°



Material	Finish	Effect	art.	slope
ANODIZED ALUMINIUM	natural	silver	SOL-MRS-10	10°

# PROFILES

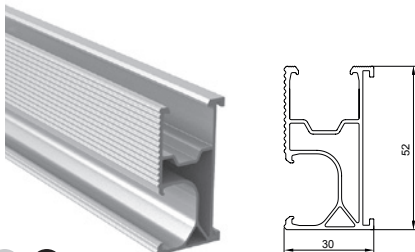

Material	Finish	Effect	art.	L
ANODIZED ALUMINIUM	natural	silver	SOL-R52-2200	2200
			SOL-R52-3000	3000
		black	SOL-R52-3000-B	3000
		silver	SOL-R52-4700	4700
		black	SOL-R52-4700-B	4700
		silver	SOL-R52-5000	5000
	black	SOL-R52-5000-B	5000	

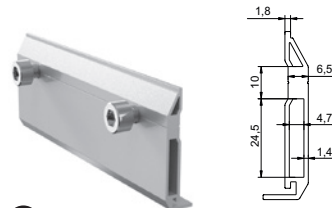

Material	Finish	Effect	art.	L
ANODIZED ALUMINIUM	natural	silver	SOL-SFR-01	150
		black	SOL-SFR-01-B	150



Material	Finish	art.
Rubber (EPDM)	black	SOL-REC



# PROFILES

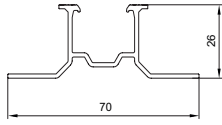

Material	Finish	Effect	art.	L
ANODIZED ALUMINIUM	natural	silver	SOL-TRB-D10	385

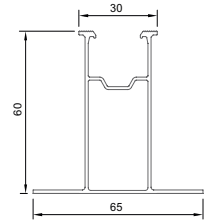

Material	Finish	Effect	art.	L
ANODIZED ALUMINIUM	natural	silver	SOL-TRB-D13	385

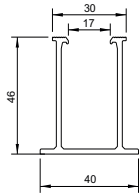

Material	Finish	Effect	art.	L
ANODIZED ALUMINIUM	natural	silver	SOL-TRB-D14	200

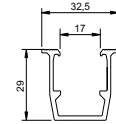

Material	Finish	Effect	art.	L
ANODIZED ALUMINIUM	natural	silver	SOL-TRB-D11	120

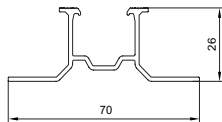
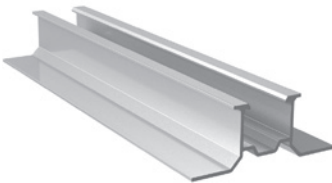

Material	Finish	Effect	art.	L
ANODIZED ALUMINIUM	natural	silver	SOL-R26-4700	4700
			SOL-R26-5000	5000

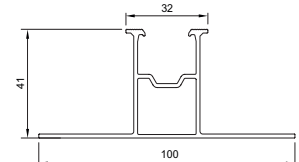
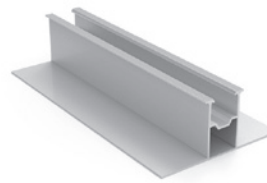

Material	Finish	Effect	art.	L
ANODIZED ALUMINIUM	natural	silver	SOL-R41-2-2500	2500
			SOL-R41-2-2900	2900
			SOL-R41-2-4700	4700
			SOL-R41-2-5000	5000

# CLAMPS

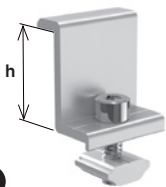

Material	Finish	Effect	art.	h
ANODIZED ALUMINIUM	natural	silver	SOL-FEC-30	30
		black	SOL-FEC-30-B	
		silver	SOL-FEC-35	35
		black	SOL-FEC-35-B	

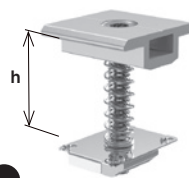

Material	Finish	Effect	art.	h
ANODIZED ALUMINIUM	natural	silver	SOL-EIC	30-40
		black	SOL-EIC-B	

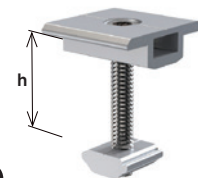

Material	Finish	Effect	art.	h
ANODIZED ALUMINIUM	natural	silver	SOL-AIC	30-40

# ACCESSORIES



# 1.4 PITCHED ROOF

TRAPEZE ADJUSTABLE CONSTRUCTION

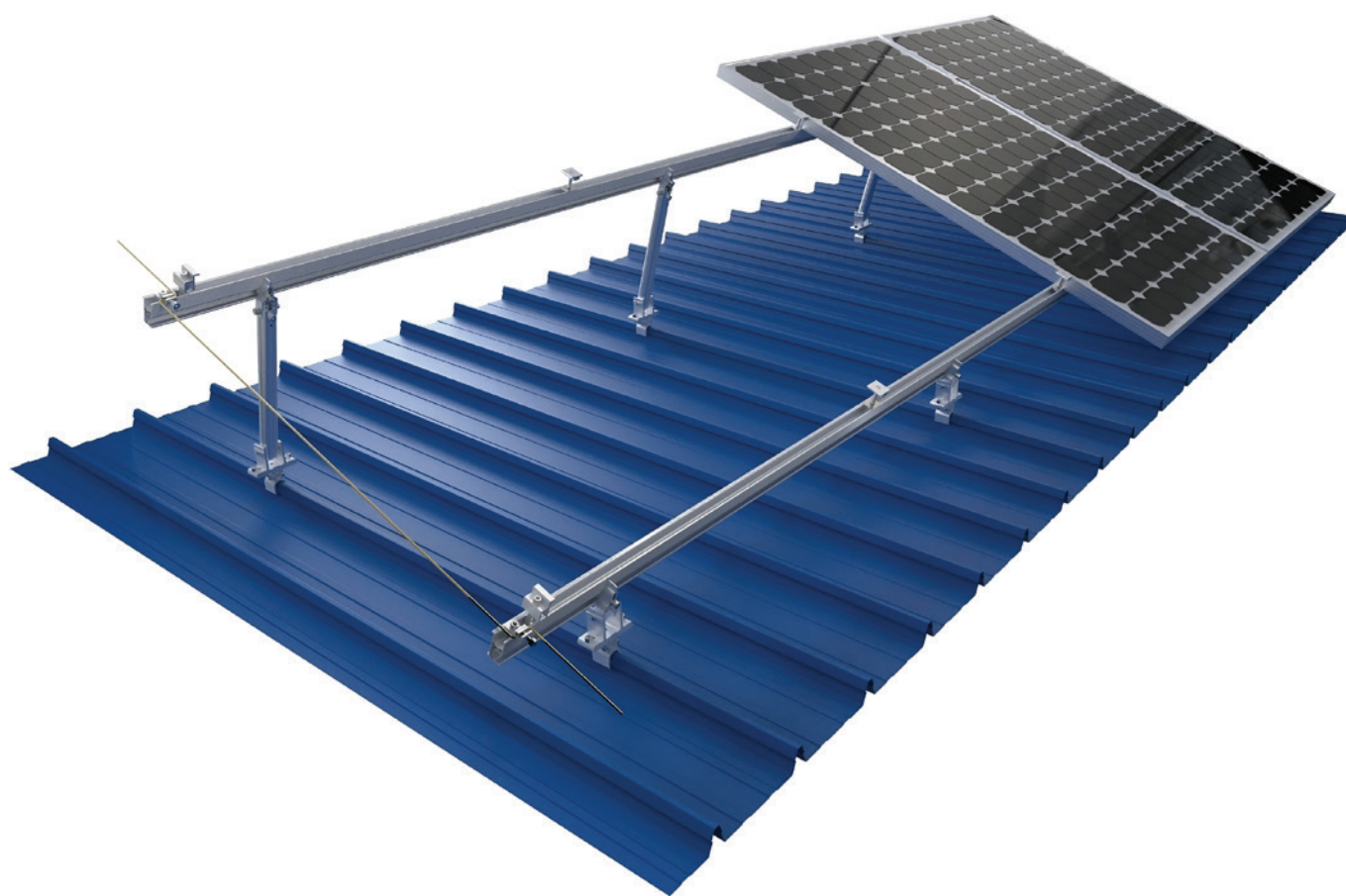

## SPECIFICATION

<b>Application</b>	Sheet metal roof, flat concrete roof
<b>Slope</b>	10-15°, 15-30°, 30-60°
<b>Material</b>	AL 6005-T5, SUS 304, EPDM
<b>Finish</b>	AL6005-T5 elox

<b>Orientation</b>	Portrait, Landscape
<b>Warranty</b>	10 years
<b>LOAD</b>	60km/h 1,4kN/m <sup>2</sup>

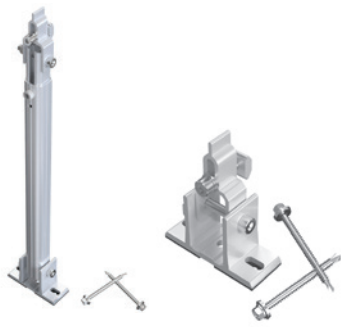

## STATIVE L1

SYSTEM 10-15  
SYSTEM 15-30

SOL-ARL-1015  
SOL-ARL-1530  
SOL-AFL



## STATIVE L3

SYSTEM FIX-25°  
SYSTEM 10-60°

SOL-FTP-25  
SOL-ATP-1015  
SOL-ATP-1530  
SOL-ATP-3060

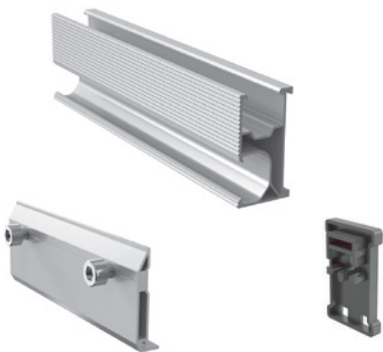

## PROFILES

SOL-R52-...



## CLAMPS

SOL-FEC...  
SOL-AEC  
SOL-EIC



## ACCESSORIES



## STATIVES - L1 (10-15° / 15-30°)



Material	Finish	Effect	art.	description	slope
ANODIZED ALUMINIUM	natural	silver	SOL-ARL-1015	set (UPPER STATIVE)	10°-15°
			SOL-ARL-1530		15°-30°

Material	Finish	Effect	art.	description
ANODIZED ALUMINIUM	natural	silver	SOL-AFL	set (BOTTOM STATIVE)

## STATIVES - L3 (FIX-X / TELESCOPE 10-60°)



Material	Finish	Effect	art.	description
ANODIZED ALUMINIUM	natural	silver	SOL-FTP-25	25° FIX SET

Material	Finish	Effect	art.	description
ANODIZED ALUMINIUM	natural	silver	SOL-ATP-1015	10°-15° ADJUST. - set
			SOL-ATP-1530	15°-30° ADJUST. - set
			SOL-ATP-3060	30°-60° ADJUST. - set

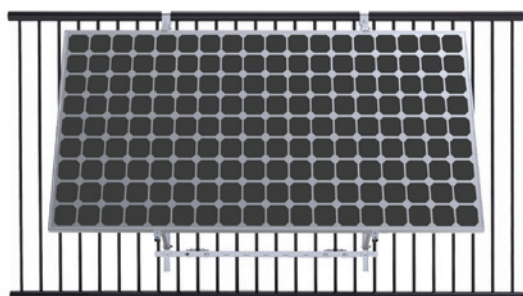

Material	Finish	Effect	art.
ANODIZED ALUMINIUM	natural	silver	SOL-BAL-01

## PROFILES

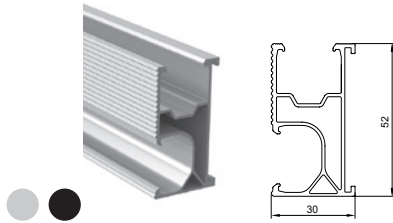

Material	Finish	Effect	art.	L
ANODIZED ALUMINIUM	natural	silver	SOL-R52-2200	2200
		black	SOL-R52-3000	3000
		black	SOL-R52-3000-B	3000
		silver	SOL-R52-4700	4700
		black	SOL-R52-4700-B	4700
		silver	SOL-R52-5000	5000
		black	SOL-R52-5000-B	5000



Material	Finish	Effect	art.	L
ANODIZED ALUMINIUM	natural	silver	SOL-SFR-01	150
		black	SOL-SFR-01-B	150



Material	Finish	art.
Rubber (EPDM)	black	SOL-REC

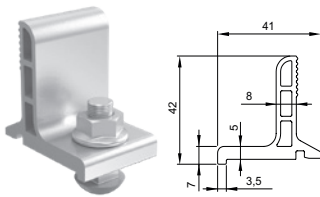

Material	Finish	Effect	art.
ANODIZED ALUMINIUM	natural	silver	SOL-RCC

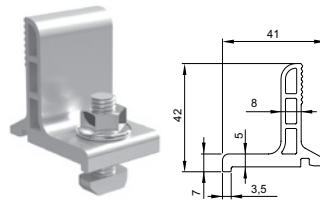

Material	Finish	Effect	art.
ANODIZED ALUMINIUM	natural	silver	SOL-RCB

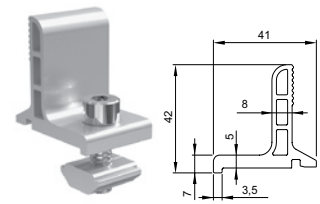

Material	Finish	Effect	art.
ANODIZED ALUMINIUM	natural	silver	SOL-RCN

1.4  
PITCHED ROOF  
ADJUSTABLE CONSTRUCTION

## CLAMPS

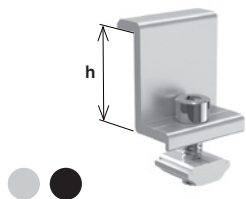

Material	Finish	Effect	art.	h
ANODIZED ALUMINIUM	natural	silver	SOL-FEC-30	30
		black	SOL-FEC-30-B	30
		silver	SOL-FEC-35	35
		black	SOL-FEC-35-B	35

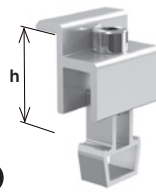

Material	Finish	Effect	art.	h
ANODIZED ALUMINIUM	natural	silver	SOL-AEC	30-35
		black	SOL-AEC-B	30-35

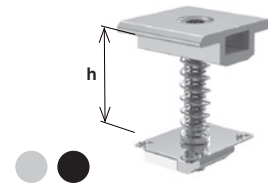

Material	Finish	Effect	art.	h
ANODIZED ALUMINIUM	natural	silver	SOL-EIC	30-40
		black	SOL-EIC-B	30-40

## ACCESSORIES



Material	Finish	Effect	art.
ANODIZED ALUMINIUM	natural	silver	SOL-ELG-02

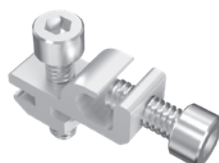

Material	Finish	Effect	art.
ANODIZED ALUMINIUM	natural	silver	SOL-ELG-03



Material	Finish	Effect	art.
ANODIZED ALUMINIUM	natural	silver	SOL-ELG-05

## FLAT ROOFS - SOLID CONSTRUCTION

### 2.1 SOLAR-PRO

### 2.2 SOLAR-ULT

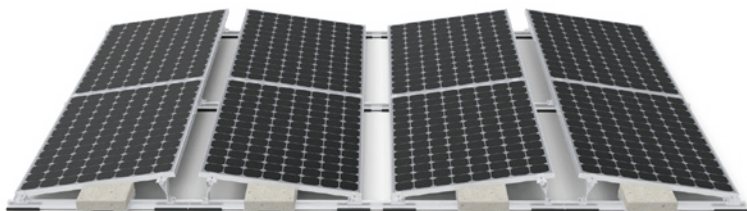

SOLAR-PRO

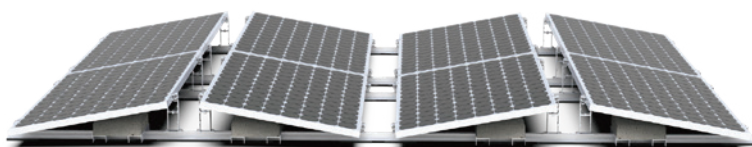
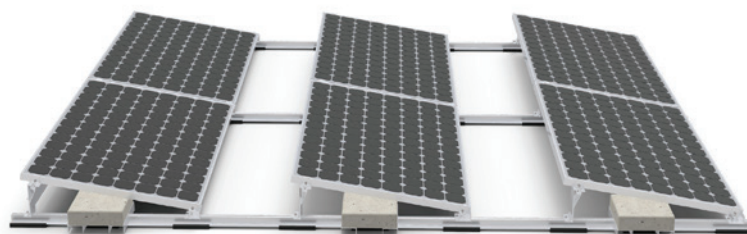

SOLAR-ULT



#### SPECIFICATION

##### System SOLAR-PRO (PRO 10, PRO 15)

Application	Flat roof
Slope	10° or 15°
Material	extrude aluminium profile 6005 T5
Assemble mat.	AISI 304
Finish	Elox
Orientation	Horizontal

##### System SOLAR-ULT

Application	Concrete flat roof and metal sheet roof
Slope	10°
Material	extrude aluminium profile 6005 T5, EPDM
Assemble mat.	AISI 304
Finish	Elox
Orientation	Horizontal

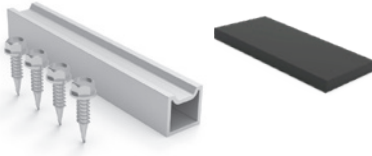
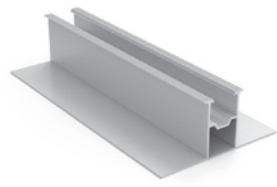

## PROFILES

SOL-R41-2...  
SOL-BST-02  
SOL-SFR-04



## HOLDERS SYSTEM PRO

SLOPE 10°

SLOPE 15°

SOL-BPF-10  
SOL-BPR-10  
...  
SOL-BPF-15  
SOL-BPR-15  
...

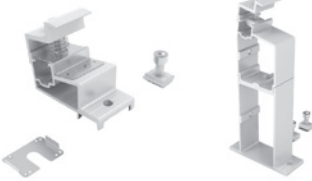

## HOLDERS SYSTEM ULT

SLOPE 10°

SLOPE 15°

SOL-BPF-10  
SOL-BPR-10  
  
SOL-BPF-15  
SOL-BPR-15



## CLAMPS

SOL-FEC...  
SOL-AEC  
SOL-EIC

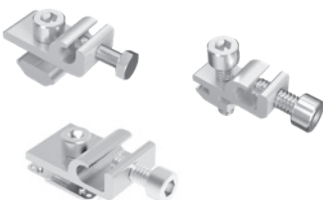

## ACCESSORIES



EAST + WEST

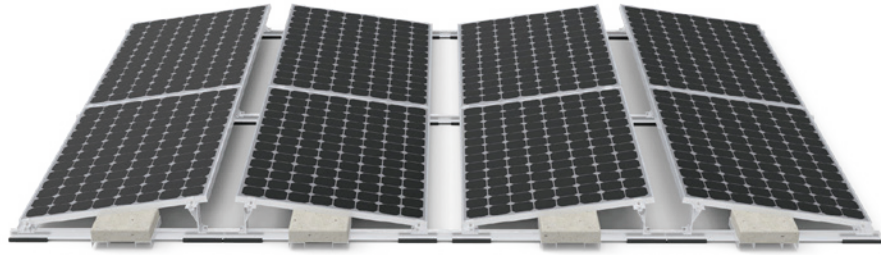

SOUTH

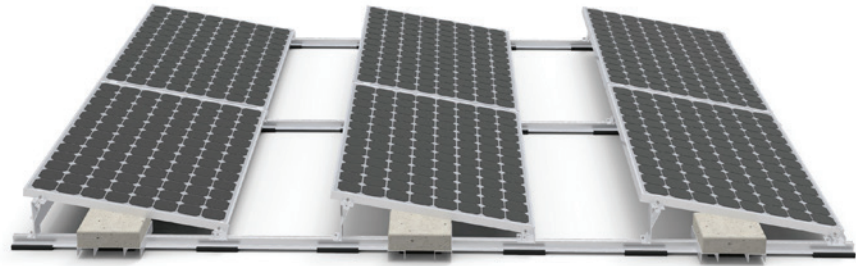

PROFILY PROFILES

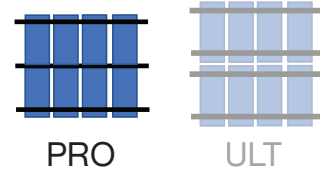

PRO

ULT

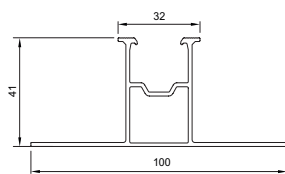
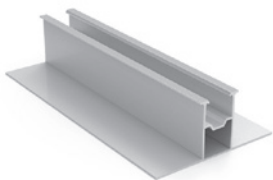

1

Material	Finish	Effect	art.	L
ANODIZED ALUMINIUM	natural	silver	SOL-R41-2-2500	2500
			SOL-R41-2-2900	2900
			SOL-R41-2-4700	4700
			SOL-R41-2-5000	5000

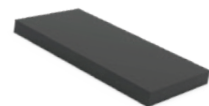
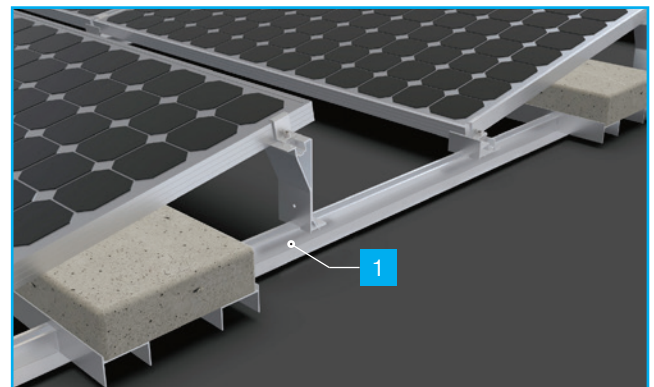

Material	Finish	Effect	art.
ANODIZED ALUMINIUM	natural	silver	SOL-BST-02

Material	Finish	Effect	art.
ANODIZED ALUMINIUM	natural	silver	SOL-SFR-04

Material	Effect	art.
FOAM (EPDM)	black	SOL-EFT-03



## HOLDERS - PRO 10°



Material	Finish	Effect	art.	slope
ANODIZED ALUMINIUM	natural	silver	SOL-BPF-10	10°



Material	Finish	Effect	art.	slope
ANODIZED ALUMINIUM	natural	silver	SOL-BPR-10	10°



Material	Finish	Effect	art.	L	slope
ANODIZED ALUMINIUM	natural	silver	SOL-BPW-10	2350	10°

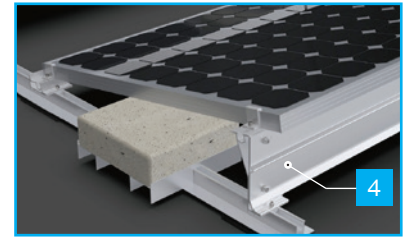
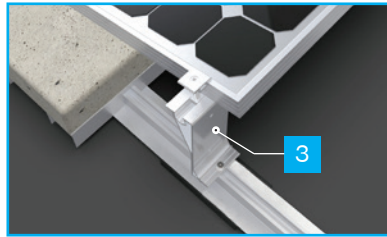
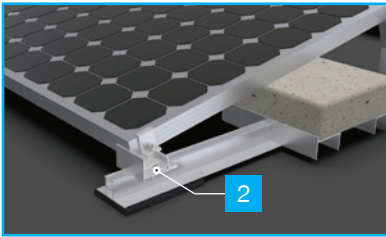

## HOLDERS - PRO 15°



Material	Finish	Effect	art.	slope
ANODIZED ALUMINIUM	natural	silver	SOL-BPF-15	15°



Material	Finish	Effect	art.	slope
ANODIZED ALUMINIUM	natural	silver	SOL-BPR-15	15°



Material	Finish	Effect	art.	L	slope
ANODIZED ALUMINIUM	natural	silver	SOL-BPW-15	2350	15°

## CLAMPS

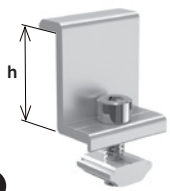

Material	Finish	Effect	art.	h
ANODIZED ALUMINIUM	natural	silver	SOL-FEC-30	30
		black	SOL-FEC-30-B	
		silver	SOL-FEC-35	35
		black	SOL-FEC-35-B	

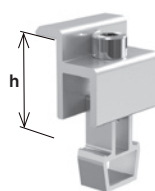

Material	Finish	Effect	art.	h
ANODIZED ALUMINIUM	natural	silver	SOL-AEC	30-35
		black	SOL-AEC-B	

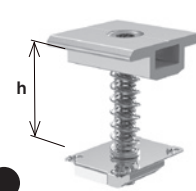

Material	Finish	Effect	art.	h
ANODIZED ALUMINIUM	natural	silver	SOL-EIC	30-40
		black	SOL-EIC-B	

## ACCESSORIES



Material	Finish	Effect	art.
ANODIZED ALUMINIUM	natural	silver	SOL-ELG-02

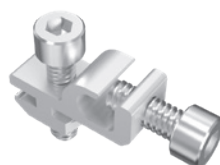

Material	Finish	Effect	art.
ANODIZED ALUMINIUM	natural	silver	SOL-ELG-03



Material	Finish	Effect	art.
ANODIZED ALUMINIUM	natural	silver	SOL-ELG-05

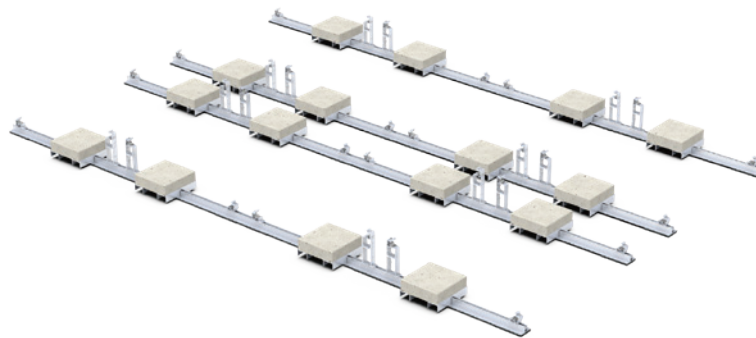
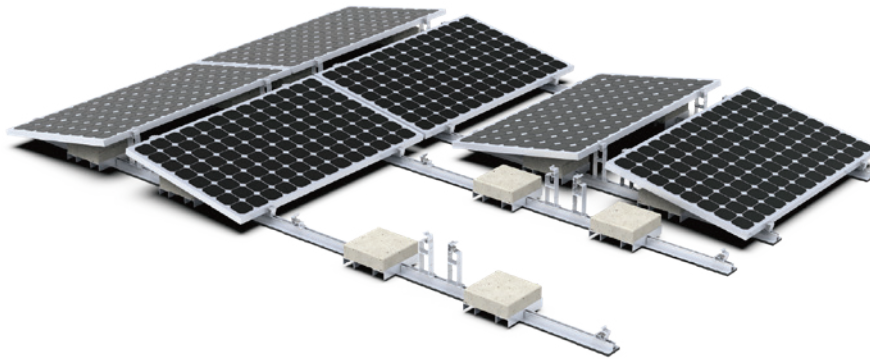

2.2  
FLAT ROOFS  
SOLAR ULT

**PROFILES** - ULT 10°/15°

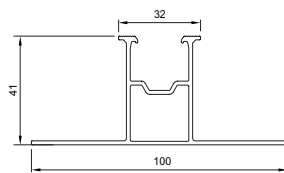
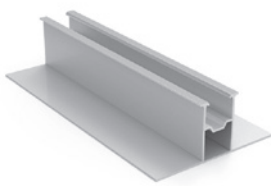
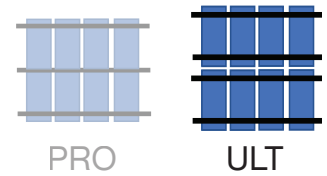

1

Material	Finish	Effect	art.	L
ANODIZED ALUMINIUM	natural	silver	SOL-R41-2-2500	2500
			SOL-R41-2-2900	2900
			SOL-R41-2-4700	4700
			SOL-R41-2-5000	5000

Material	Finish	Effect	art.
ANODIZED ALUMINIUM	natural	silver	SOL-SFR-04

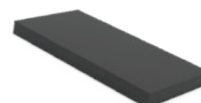

Material	Finish	Effect	art.
ANODIZED ALUMINIUM	natural	silver	SOL-BST-02

Material	Effect	art.
FOAM (EPDM)	black	SOL-EFT-03

## HOLDERS - ULT 10°



2

Material	Finish	Effect	art.	slope
ANODIZED ALUMINIUM	natural	silver	SOL-BUF-10	10°



3

Material	Finish	Effect	art.	slope
ANODIZED ALUMINIUM	natural	silver	SOL-BUR-10	10°



4

Material	Finish	Effect	art.	L	slope
ANODIZED ALUMINIUM	natural	silver	SOL-BUW-10	2350	10°

## HOLDERS - ULT 15°



Material	Finish	Effect	art.	slope
ANODIZED ALUMINIUM	natural	silver	SOL-BUF-15	15°



Material	Finish	Effect	art.	slope
ANODIZED ALUMINIUM	natural	silver	SOL-BUR-15	15°



Material	Finish	Effect	art.	L	slope
ANODIZED ALUMINIUM	natural	silver	SOL-BUW-15	2350	15°

2.2

FLAT ROOFS  
SOLAR ULT

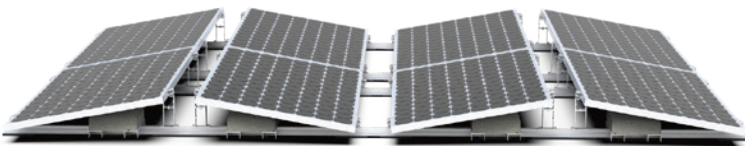

East - West 10°, for a concrete flat roof

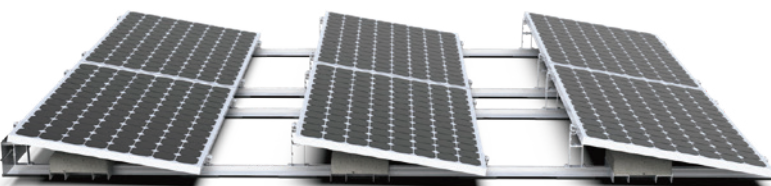
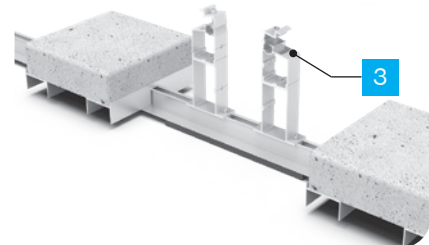

South or North 10°, for a concrete flat roof

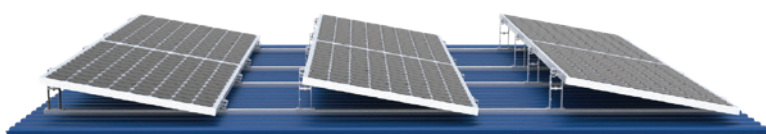
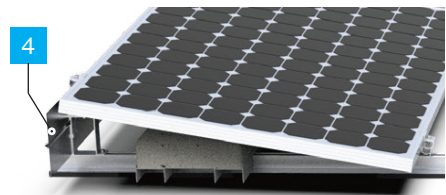

South or North 10°, for a trapezoidal sheet roof

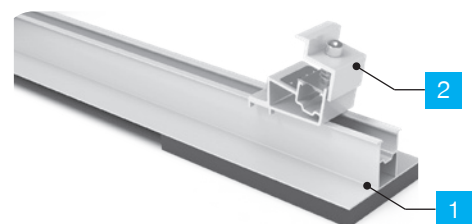

## ACCESSORIES



# 3

## GROUND SYSTEMS

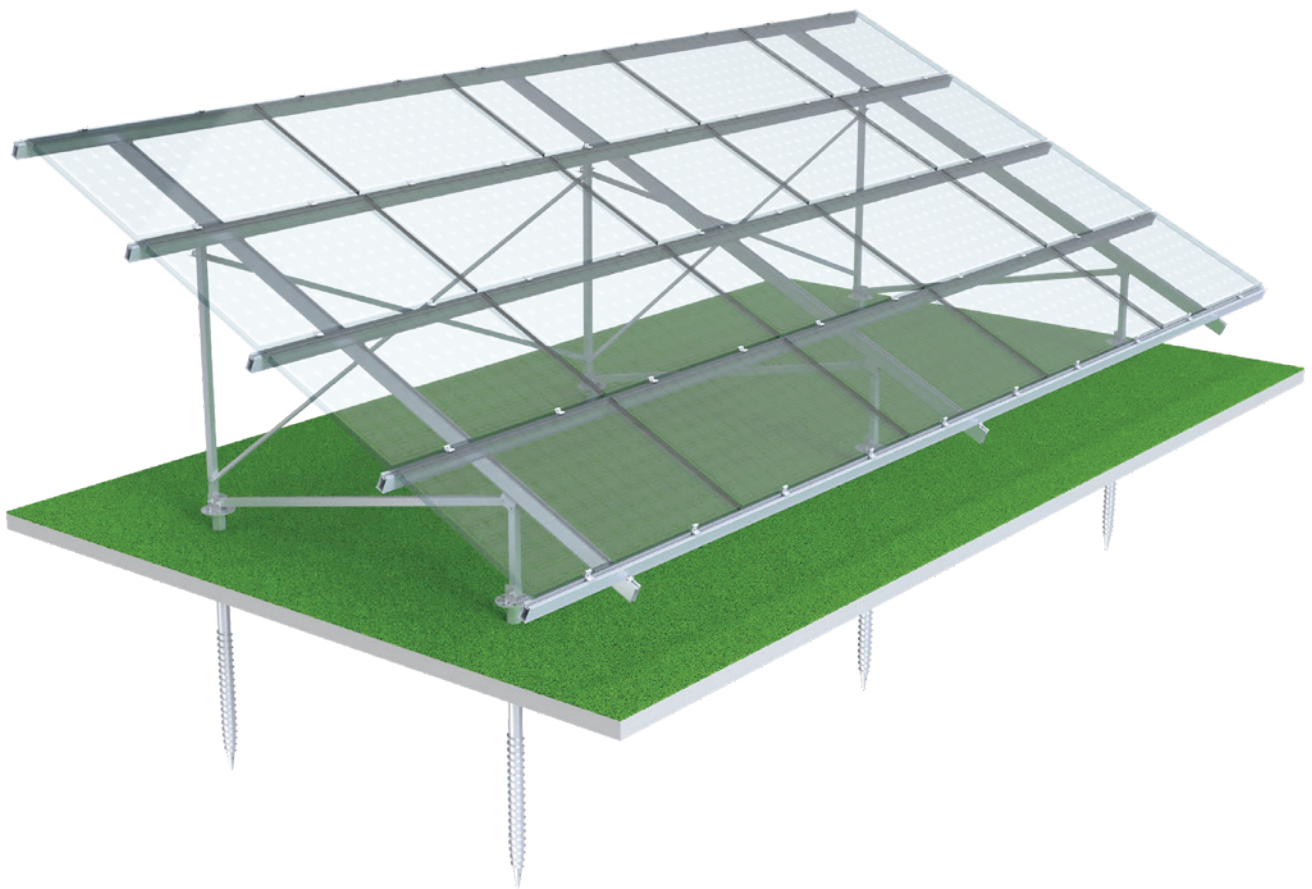

### SPECIFICATION

<b>Application</b>	Flat concrete roof, free terrain
<b>Slope</b>	Custom
<b>Material</b>	AL 6005-T5, SUS 304, Q235
<b>Assemble mat.</b>	AISI 304

<b>Finish</b>	AL6005-T5 elox, Q235 hot galvanizing
<b>Orientation</b>	Portrait, Landscape
<b>Warranty</b>	10 years
<b>LOAD</b>	60km/h 1,4kN/m <sup>2</sup>



## HOLDERS

SOL-CH2-01  
SOL-CH2-02  
SOL-GB2-01  
SOL-GB2-02



## PRE-ASSEMBLED SUPPORTS

TYP W

TYP N

TYP V

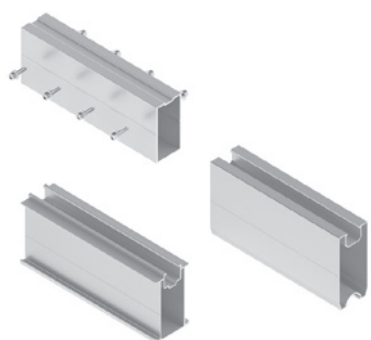

## PROFILES

SOL-R80  
SOL-SFR-R80  
SOL-B95

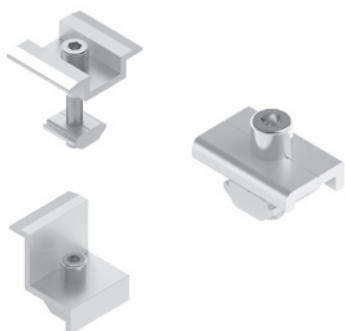

## CLAMPS

SOL-GEC-XX  
SOL-GIC-XX  
SOL-GRC  
SOL-GS2

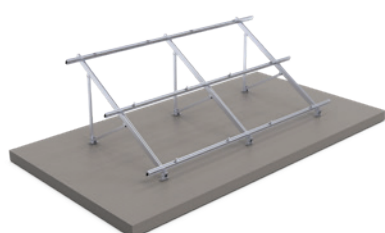

## SETS



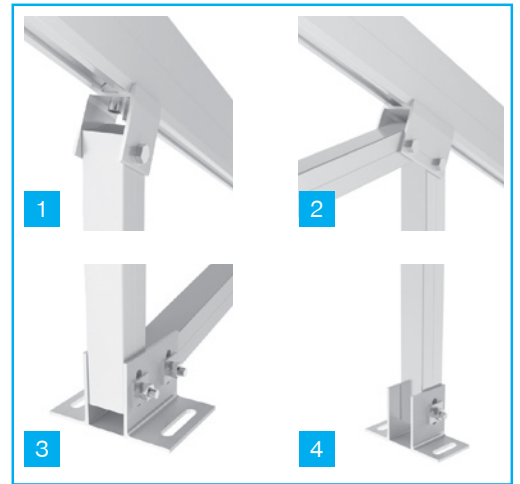
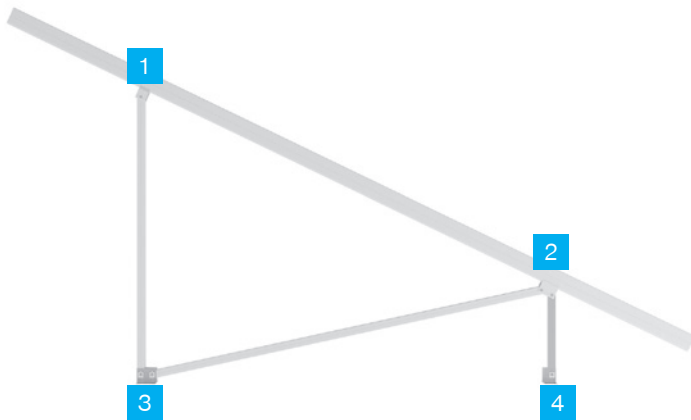

HOLDERS



1	Material	art.
	ANODIZED ALUMINIUM	SOL-CH2-01



2	Material	art.
	ANODIZED ALUMINIUM	SOL-CH2-02



3	Material	art.
	ANODIZED ALUMINIUM	SOL-GB2-02



4	Material	art.
	ANODIZED ALUMINIUM	SOL-GB2-01

SUPPORTS

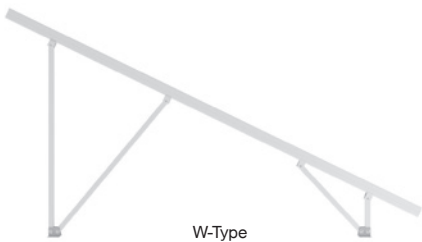

Material	Finish	Effect	art.
ANODIZED ALUMINIUM	natural	silver	SOL-W-FRAME

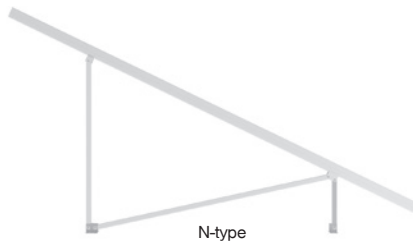

Material	Finish	Effect	art.
ANODIZED ALUMINIUM	natural	silver	SOL-N-FRAME



Material	Finish	Effect	art.
ANODIZED ALUMINIUM	natural	silver	SOL-V-FRAME

# PROFILES



Material	art.
<b>ANODIZED ALUMINIUM</b>	<b>SOL-R80</b>



Material	art.
<b>ANODIZED ALUMINIUM</b>	<b>SOL-SFR-R80</b>



Material	art.
<b>ANODIZED ALUMINIUM</b>	<b>SOL-B95</b>



Material	art.
<b>ANODIZED ALUMINIUM</b>	<b>SOL-GS2</b>



Material	art.
<b>steel Zn</b>	<b>SOL-GF1-1600</b>

# CLAMPS



Material	art.
<b>ANODIZED ALUMINIUM</b>	<b>SOL-GEC</b>



Material	art.
<b>ANODIZED ALUMINIUM</b>	<b>SOL-GIC</b>



Material	art.
<b>ANODIZED ALUMINIUM</b>	<b>SOL-GRC</b>

# GROUND SET



Material	art.	FV panel (optional)
<b>ANODIZED ALUMINIUM</b>	<b>SOL-W-GROUND-SET</b>	20

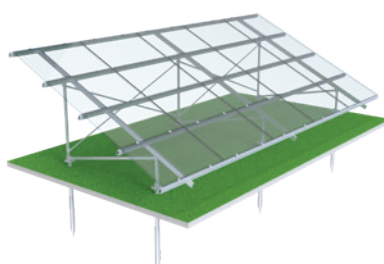

Material	art.	FV panel (optional)
<b>ANODIZED ALUMINIUM</b>	<b>SOL-N-GROUND-SET</b>	20

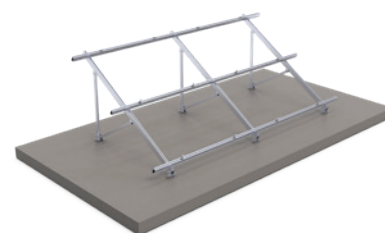

Material	art.	FV panel (optional)
<b>ANODIZED ALUMINIUM</b>	<b>SOL-V-GROUND-SET</b>	4



Material	art.	FV panel (optional)
<b>FE-MAGNELIS</b>	<b>SOL-WS026M-SET8</b>	8
	<b>SOL-WS026M-SET24</b>	24

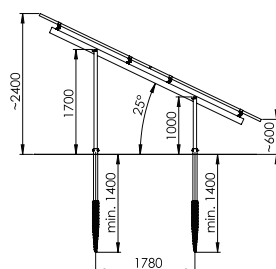

# 4

## CARPORT

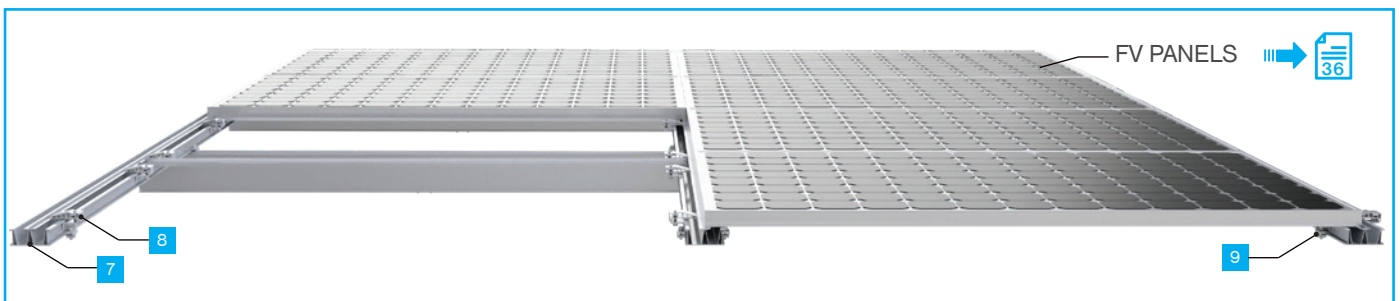
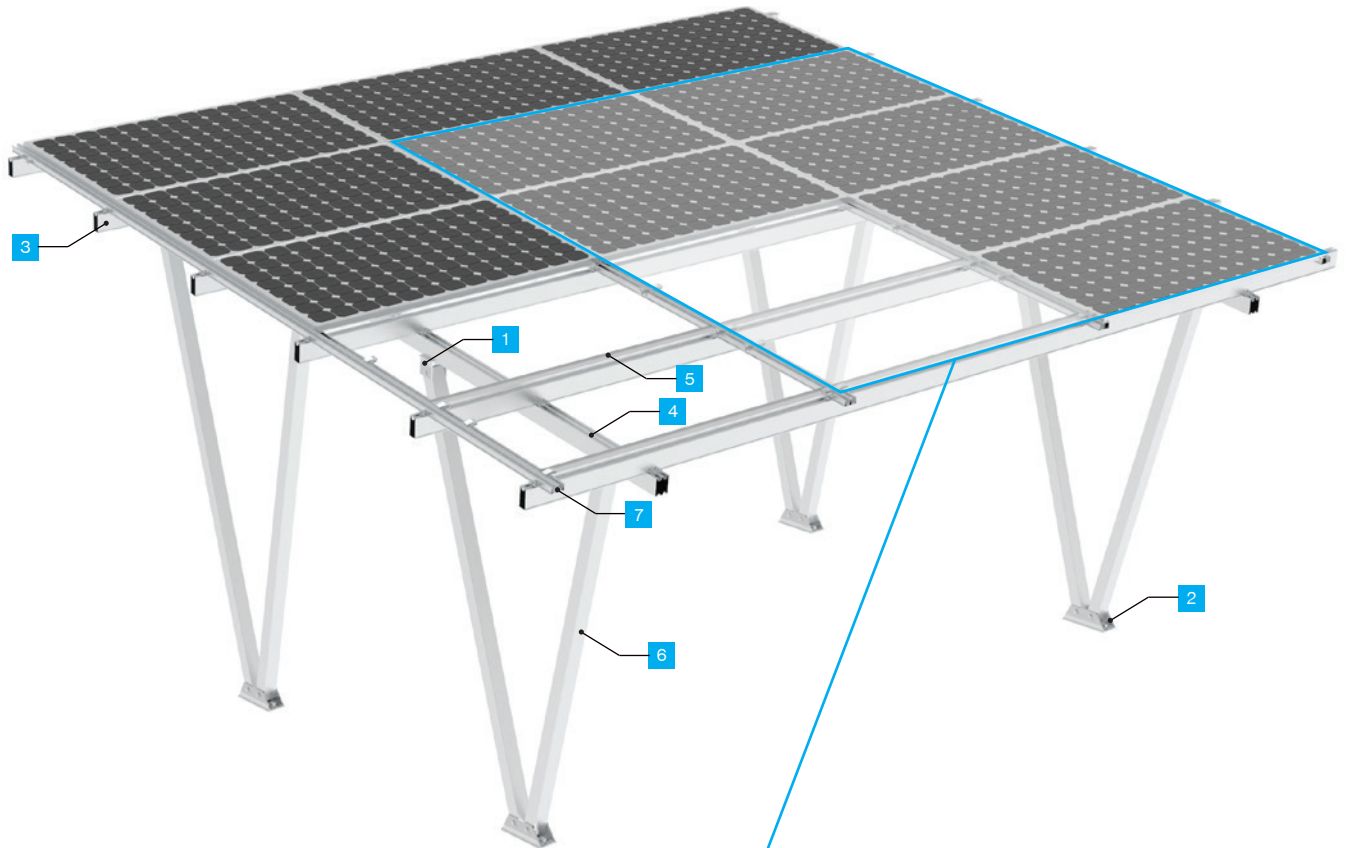

### SPECIFICATION

<b>Application</b>	Solar parking station
<b>Slope</b>	5°, 8°, 10° or custom
<b>Material</b>	AL 6005-T5, SUS 304
<b>Finish</b>	AL6005-T5 elox

<b>Orientation</b>	Portrait, Landscape
<b>Warranty</b>	10 years
<b>LOAD</b>	35km/h 2,5kN/m <sup>2</sup>
<b>Norms</b>	AS/NZ1170.2, JIS C 8955, MCS 012, TUV, UL2703



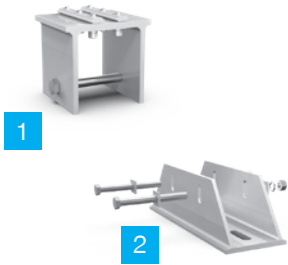

## HOLDERS

SOL-CPH-01  
SOL-CPS-02

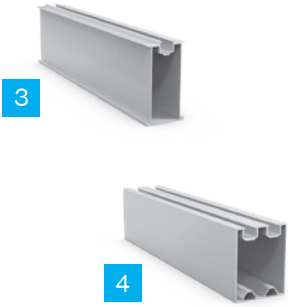

## PROFILES

SOL-R125..  
SOL-B110..

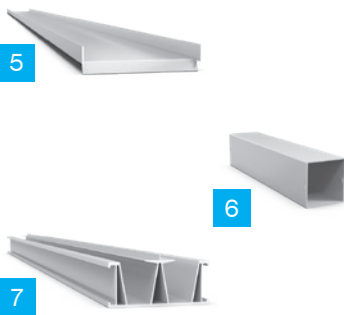

## ACCESSORIES

SOL-CPS...  
SOL-RWT...  
SOL-HWT...

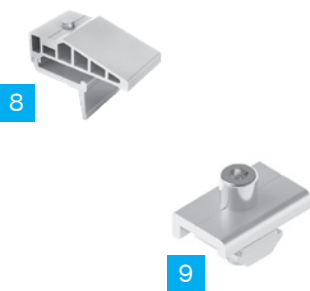

## CLAMPS

SOL-FEC  
SOL-GRC



## SETS

SOL-CARPORT2-SET



HOLDERS



Material	Finish	Effect	art.
ANODIZED ALUMINIUM	natural	silver	SOL-CPH-01

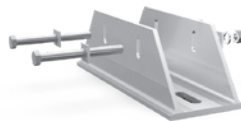

Material	Finish	Effect	art.
ANODIZED ALUMINIUM	natural	silver	SOL-CPS-02



PROFILES

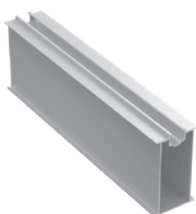

Material	Finish	Effect	art.	L
ANODIZED ALUMINIUM	natural	silver	SOL-R125-2200	2200
			SOL-R125-5000	5000



Material	Finish	Effect	art.	L
ANODIZED ALUMINIUM	natural	silver	SOL-SFR-R125	500

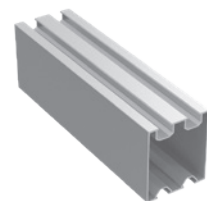

Material	Finish	Effect	art.	L
ANODIZED ALUMINIUM	natural	silver	SOL-B110-5700	5700

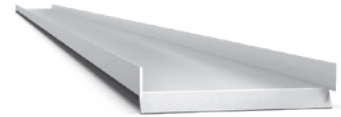
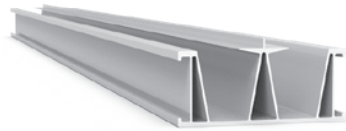

Material	Finish	Effect	art.	L
ANODIZED ALUMINIUM	natural	silver	SOL-CPS-2273	2273
			SOL-CPS-2547	2547
			SOL-CPS-2877	2877
			SOL-CPS-3095	3095

Material	Finish	Effect	art.	L
ANODIZED ALUMINIUM	natural	silver	SOL-RWT-5800	5800

Material	Finish	Effect	art.	L
ANODIZED ALUMINIUM	natural	silver	SOL-HWT	2220

## CLAMPS

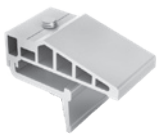

Material	Finish	Effect	art.
ANODIZED ALUMINIUM	natural	silver	SOL-PVC

Material	Finish	Effect	art.
ANODIZED ALUMINIUM	natural	silver	SOL-GRC

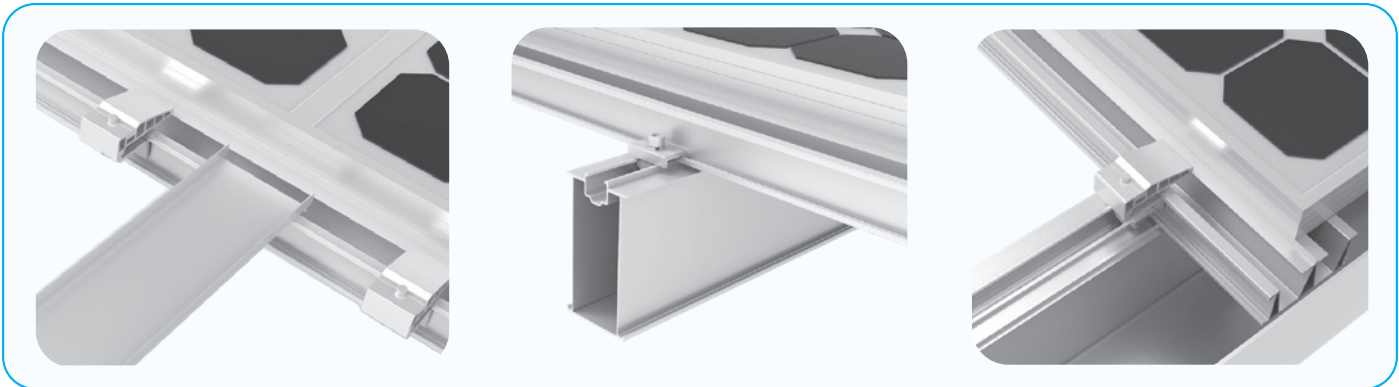

## ACCESSORIES



## CARPORT SET - WATERPROOF

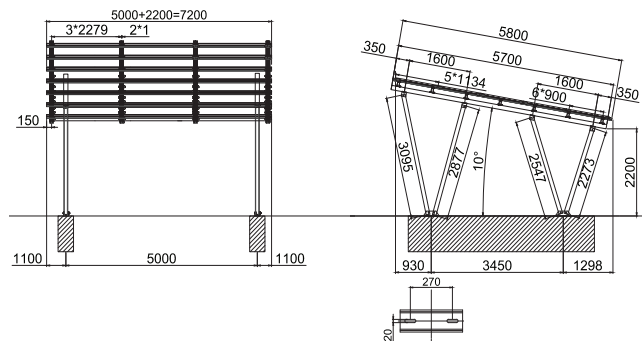

Material	Finish	Effect	art.										
ANODIZED ALUMINIUM	natural	silver	SOL-CARPORT2-SET15	SOL-R125...	SOL-SFR-R125	SOL-RWT-5800	SOL-GRC	SOL-PVC	SOL-B110-5700	SOL-CPH-01	SOL-CPS-...	SOL-CPB-02	SOL-HWT
SET CARPORT preassembled frame, FV panels not included in SET				6x 2200 8x 5000	7x	4x	84x	60x	2x	8x	2x 2273 2x 2547 2x 2877 2x 3095	4x	15x

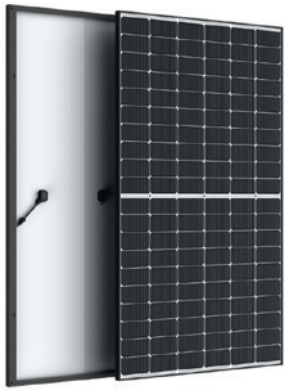

SOL-NUUKO-450-BF	
Panel type	Monocrystalline
Power	450 Wp
Weight	25,5 kg
Max. IMPP	11,01 A
Max. VOLT	40,9 V
Effectivity	21,5 %
Frame	black anod. aluminium
Dimension	2094x1038x35 mm
Operating temp.	-40°C ~ +85°C
IP rating	IP68



SOL-LONGi-550	
Panel type	Monocrystalline
Power	550 Wp
Weight	27,2 kg
Max. IMPP	13,12 A
Max. VOLT	41,95 V
Effectivity	21,5 %
Frame	black anod. aluminium
Dimension	2256x1133x35 mm
Operating temp.	-40°C ~ +85°C
IP rating	IP68

art.  
SOL-NUUKO-450-BF

art.  
SOL-LONGi-550

MIX ACCESSORIES



art.  
SOL-MC4-TOOL



art.  
SOL-MC4-EVO2-F



art.  
SOL-MC4-EVO2-M

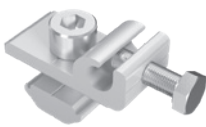

Material	Finish	Effect	art.
ANODIZED ALUMINIUM	natural	silver	SOL-ELG-02



Material	Finish	Effect	art.
ANODIZED ALUMINIUM	natural	silver	SOL-ELG-03



Material	Finish	Effect	art.
ANODIZED ALUMINIUM	natural	silver	SOL-ELG-05



Material	Finish	Effect	art.
ANODIZED ALUMINIUM	natural	silver	SOL-NBW



Material	Finish	Effect	art.
AISI304	raw	silver	SOL-TBK

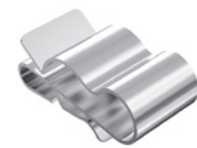

Material	Finish	Effect	art.
AISI304	raw	silver	SOL-CCP-04



Material	Finish	Effect	art.
AISI304	raw	silver	SOL-REL-B



Material	Finish	Effect	art.
AISI304	raw	silver	SOL-REL-B



color	art.	žila	L(m)
red	SOL-H1Z2Z2-K 1x4 red	1x	100
black	SOL-H1Z2Z2-K 1x4 black	4mm	
red	SOL-H1Z2Z2-K 1x6 red	1x	100
black	SOL-H1Z2Z2-K 1x6 black	6mm	

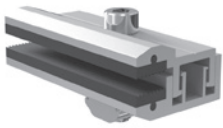

Material	Finish	Effect	art.
ANODIZED ALUMINIUM	natural	silver	SOL-TEC

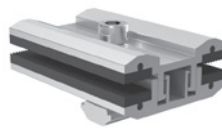

Material	Finish	Effect	art.
ANODIZED ALUMINIUM	natural	silver	SOL-TIC

PROFILY PROFILES

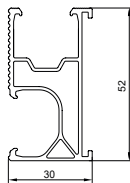
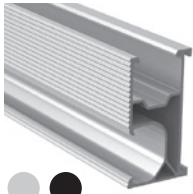

Material	Finish	Effect	art.	L
ANODIZED ALUMINIUM	natural	silver	SOL-R52-2200	2200
		black	SOL-R52-3000-B	3000
		silver	SOL-R52-4700	4700
		black	SOL-R52-4700-B	4700
		silver	SOL-R52-5000	5000
		black	SOL-R52-5000-B	5000

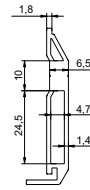

Material	Finish	Effect	art.	L
ANODIZED ALUMINIUM	natural	silver	SOL-SFR-01	150
		black	SOL-SFR-01-B	



Material	Finish	art.
Rubber (EPDM)	black	SOL-REC

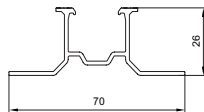

Material	Finish	Effect	art.	L
ANODIZED ALUMINIUM	natural	silver	SOL-TRB-D10	385

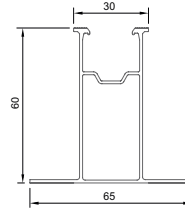

Material	Finish	Effect	art.	L
ANODIZED ALUMINIUM	natural	silver	SOL-TRB-D13	385

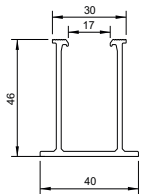

Material	Finish	Effect	art.	L
ANODIZED ALUMINIUM	natural	silver	SOL-TRB-D14	200

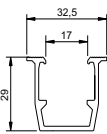

Material	Finish	Effect	art.	L
ANODIZED ALUMINIUM	natural	silver	SOL-TRB-D11	120

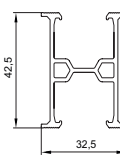

Material	Finish	Effect	art.	L
ANODIZED ALUMINIUM	natural	silver	SOL-R42-5000	5000

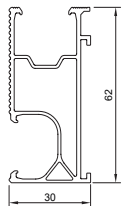
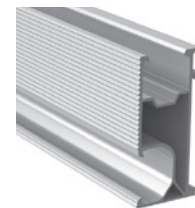

Material	Finish	Effect	art.	L
ANODIZED ALUMINIUM	natural	silver	SOL-R62-5000	5000

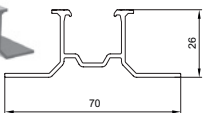
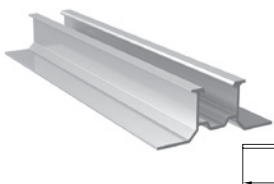

Material	Finish	Effect	art.	L
ANODIZED ALUMINIUM	natural	silver	SOL-R26-4700	4700
		silver	SOL-R26-5000	5000

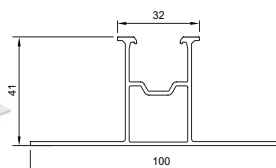
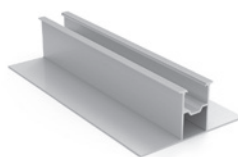

Material	Finish	Effect	art.	L
ANODIZED ALUMINIUM	natural	silver	SOL-R41-2-2500	2500
		silver	SOL-R41-2-2900	2900
		silver	SOL-R41-2-4700	4700
		silver	SOL-R41-2-5000	5000



Art.  
PNL/SOLAR-SAMPLE

*new*

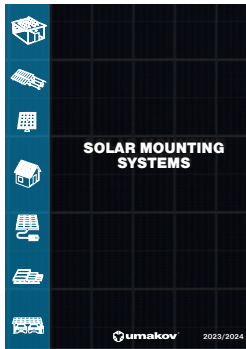

Art.  
kat-solar systems 23-24

*new*



Art.  
kat-fence systems 23-24

*new*



Art.  
kat-glass railings 23-24

*new*



Art.  
kat-post railings 23-24



Art.  
kat-glass systems 23-24



Art.  
kat-forged 23-24

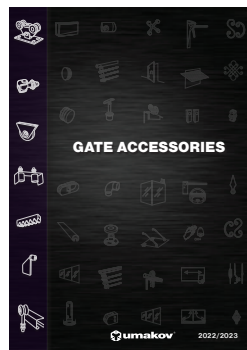

Art.  
kat-gates 23-24

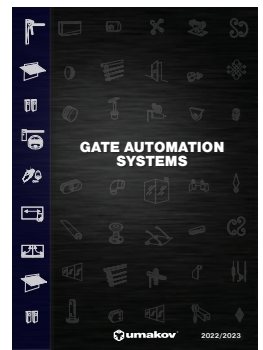

Art.  
kat-automations 23-24